

LAST UPDATED : 2011.11.16
compatible with VW car models with RNS510



RNS 510

User manual

Contents

1. Before the installation

1.1 Main specification	3
1.2 Features	4
1.3 System diagram	5
1.4 Components	6
1.5 Exterior	7

2. Setup

2.1 DIP switch	8
2.2 KEYPAD	9
2.3 Factory mode	10
2.4 Rear parking guide line	11
2.5 OSD (on screen display)	13

3. Troubleshooting	14
--------------------	----

1.1 Main specification

1. Input Spec. (VIDEO INTERFACE)

- 3 x A/V Input (Rear video source)
- 1 x CVBS(Rear camera) Input (Rear camera source)
- 1 x Analog RGB Input (Navigation System output)
- 1 x LCD Input (Car system Input)

2. Output Spec.

- 1 x LCD Output (LCD operation)
- 4 x Audio Select (12V power comes out from 4 wires of cable by video, Navigation mode)

3. Power Spec.

- Input power : 10VDC ~ 16VDC
- Power consumption : 6WATT in maximum level

4. Switching mode

- Skip function of input video : Able to skip each input source via adjusting DIP switch.
- Able to change a mode to another by using the mode switch.
- Able to change modes and get back to the OEM screen through the genuine buttons.

1.2 Features

- Clear high definition screen
- NTSC, PAL system support
- Mode exchange via the original buttons
- Control over the position of NAVI, AV screen
- Additional function of adjusting the screen size of NAVI

1.3 System diagram

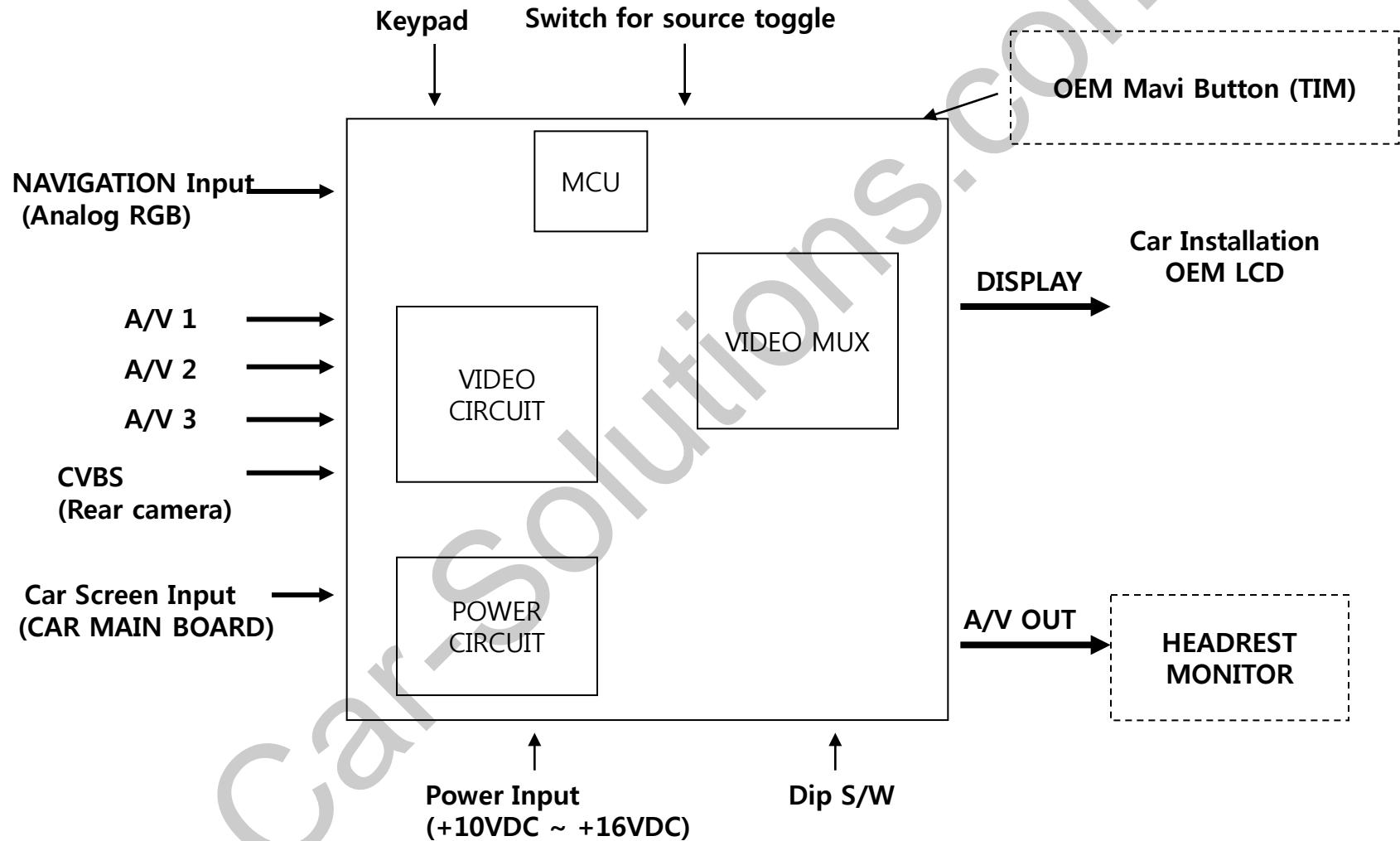

1.4 Components

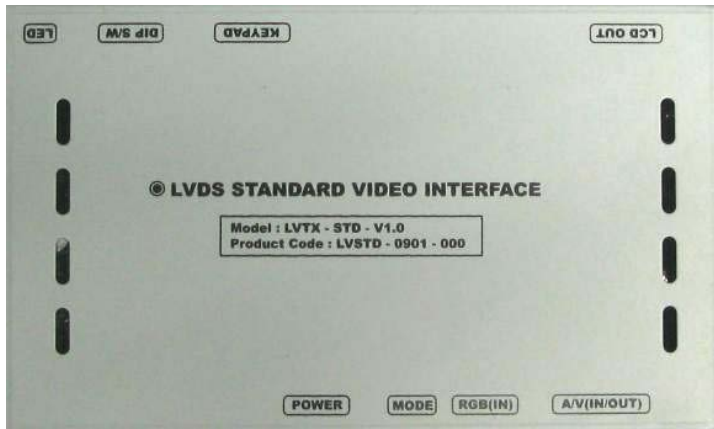

POWER cable (10P) * 1pc.
(HPOWER0005)



Mode cable * 1pc.
(HARETC0001)



RGB cable * 1pc.
(HNAVIC0002)



LVDS cable * 1pc.
(HLVDSC0006)

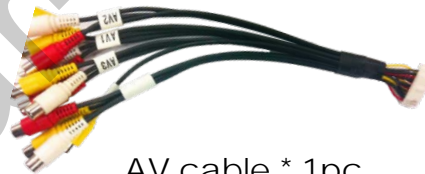

AV cable * 1pc.
(HAVCAB0002)

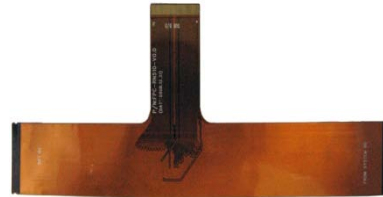

FPC cable * 1pc.
(FPCABL0011)

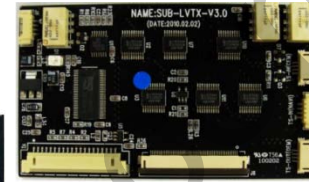

Sub board * 1pc.
(QCPASS0041)



Extension cable * 2pc.
(HTOUCH0001)
(HTOUCH0002)

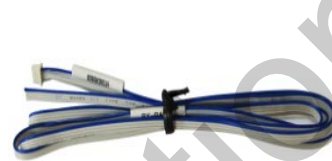

TOUCH cable * 1pc.
(HTOUCH0003)



Button cable * 1pc.
(HBUTTO0003)



FFC cable * 2pc.
(FFCABL0006)



IR cable (8P) * 1pc.
(HIRCAB0003)



Remote control * 1pc.
(REMOTE0001)



Ground cable * 1pc.
(HGROUN0001)

OR



Keypad * 1pc.
(SMTASY0063)

1.5 Exterior

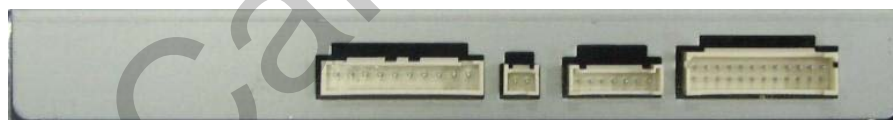
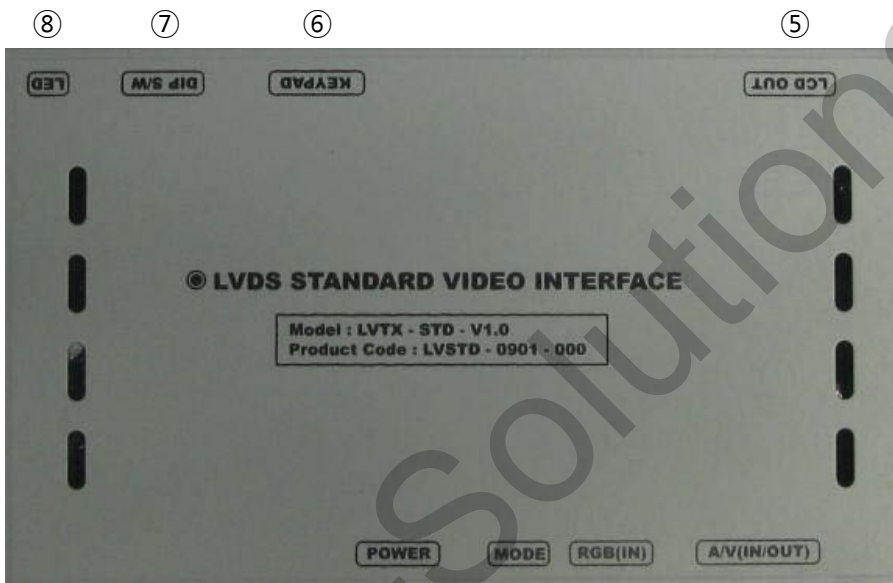

Product dimension

155mm (Horizontal length)
93mm (Vertical length)
20mm (Height)

- ① POWER
- ② MODE
- ③ RGB (IN)
- ④ AV(IN/OUT)
- ⑤ LCD OUT
- ⑥ KEYPAD
- ⑦ DIP S/W
- ⑧ LED

2.1 DIP switch

#PIN	Function	DIP S/W selection
1	RGB INPUT skip	ON : RGB mode OFF OFF : RGB Display
2	A/V 1 skip	ON : A/V1 mode OFF OFF : A/V1 Display
3	A/V 2 skip	ON : A/V2 mode OFF OFF : A/V2 Display
4	A/V 3 skip	ON : A/V3 mode OFF OFF : A/V3 Display
5	NOT USED	
6	NOT USED	
7	Rear mode	ON : REAR CAMERA mode ON OFF : MAIN rear camera
8	Selecting original NAVI	ON : Changing mode ; Main-Main-NAVI-AV1~3 (This is for original Navi) OFF : Changing mode ; Main-NAVI-AV1~3

※ ON : DOWN, OFF : UP default : all OFF

※ DIP S/W usage example

- Input mode use : A/V2, A/V3
- Use original navigation

- ▷ DIP S/W : 1,2 → ON (INPUT MODE SKIP)
- ▷ DIP S/W : 3 → OFF (enable A/V2)
- ▷ DIP S/W : 4 → OFF (enable A/V3)
- ▷ DIP S/W : 5, 6, 7 → OFF
- ▷ DIP S/W : 8 → ON



2.2 KEYPAD

※ **FACTORY MODE (Interface setting)**

: Press "UP" button about 2 seconds long and you will approach **FACTORY** mode. Also you can get there in pressing these keys in this sequence; "UP" → "DOWN" → "UP" → "MENU"



Key	Function
MENU/EXIT	Implement OSD screen
SEL/INPUT	Selection
UP	Move upward, if you press about 2 seconds long, you are able to approach the FACTORY mode.
DOWN	Move downward, if you press about 2 seconds long, you are able to reset the factory mode.

2.3 Factory mode

※ **FACTORY mode** – Press “UP” button on the keypad long about 2 seconds or press these buttons in this sequence; “UP”→“DOWN”→“UP”→“MENU”

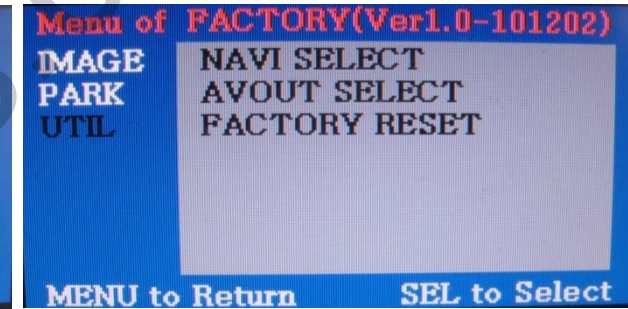
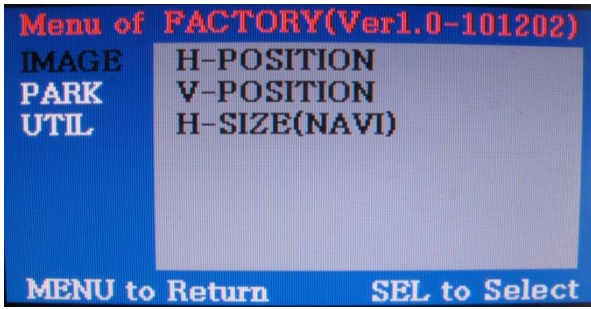

IMAGE

- H-POSITION : control over the horizontal position of the screen
- V-POSITION : control over the vertical position of the screen
- H-SIZE : control over the size of NAVI screen

PARK

- PARK ENABLE : able to choose whether the rear guide line is displayed or not with rear gear. (default-ON)
- PARK SETUP : able to adjust the position of the rear guide line with the keypad.
- SAFE ENABLE : The function that forbids drivers to change the LCD to DVD or A/V while driving. User returns to the main screen by this function. (Default : off)
(Refer to the page#11)

UTIL

- NAVI SELECT (N.C)
- AVOUT SELECT : making a choice of AVOUT output in the OEM & NAVI screen (Default – AV3)
- FACTORY RESET : reset

2.4 Rear parking guide line

※ **FACTORY mode** – Press “UP” button on the keypad long about 2 seconds.

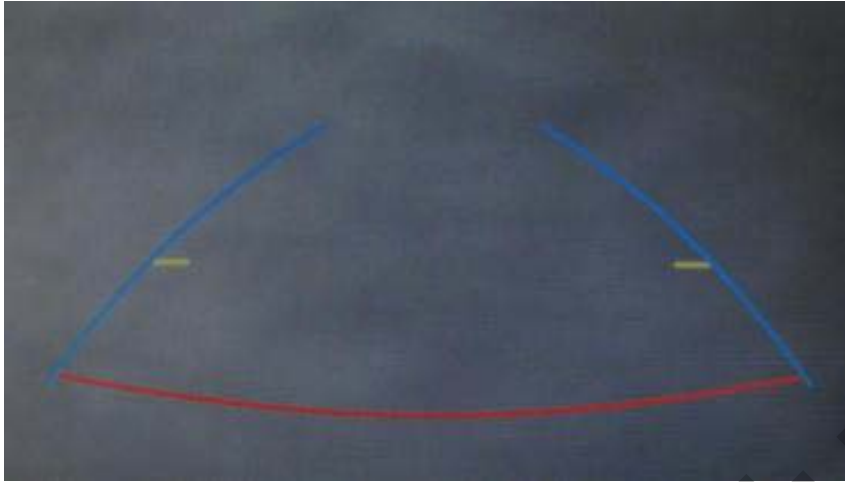

① Once you change up into rear gear, the rear parking guide line will automatically appear on the screen like the left picture.

※ **FACTORY default** : **DISPLAY - ENABLE**

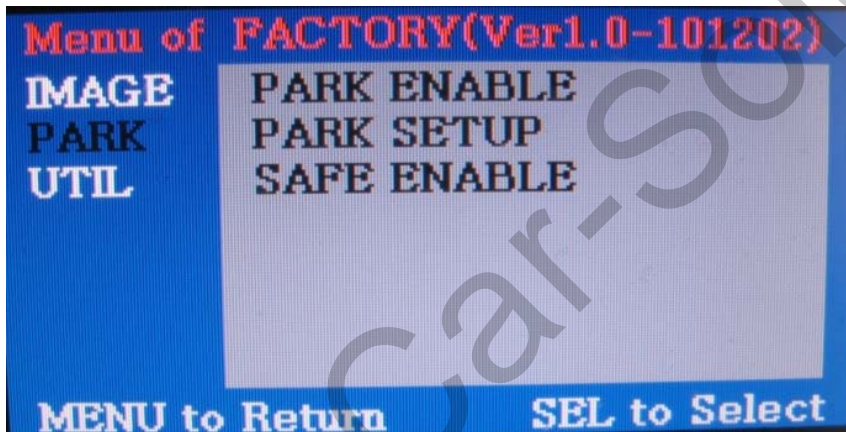

② If you press “UP” button on the keypad about 2 seconds long, you can see the left image on the screen. Now that you choose “PARK SETUP” and press “OK” on the keypad, you can control the width of the rear parking guide line.

2.4 Rear parking guide line

※ FACTORY default -Types:0, H_Pos:50, V_Pos:120

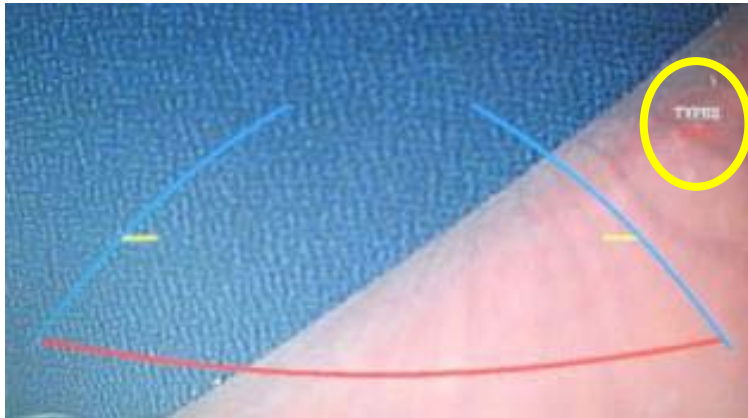

level 0

~

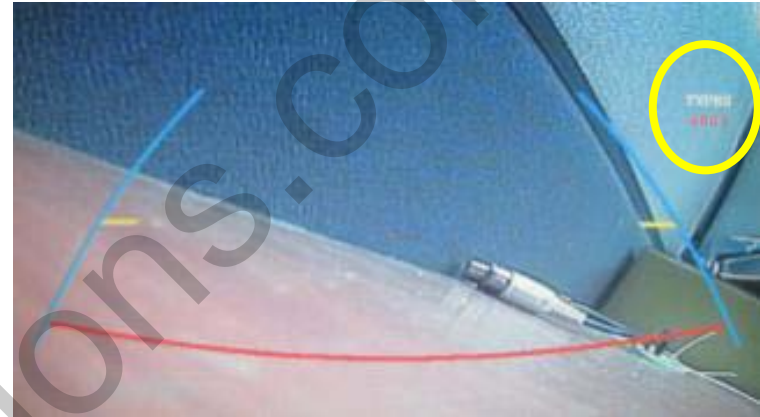

level 4

③ The width of the rear parking guide line has 5 level(0~4). After you control the level with "UP", "DOWN" button on the keypad, you can move to the horizontal positioning mode after pressing "SEL" button and saving process. (The current state is displayed right-top.)



④ After you control the horizontal position with "UP", "DOWN" button on the keypad, you can move to the vertical positioning mode after pressing "SEL" button and saving process. Once you finish that and press "SEL", all the things will be saved. (Adjustable between level 0 and level 255.)

※ Unless you want the rear parking guide line, set the value of "PARK ENABLE" as "OFF".

2.5 OSD (on screen display)

※ OSD : Press "MENU" button on the keypad.

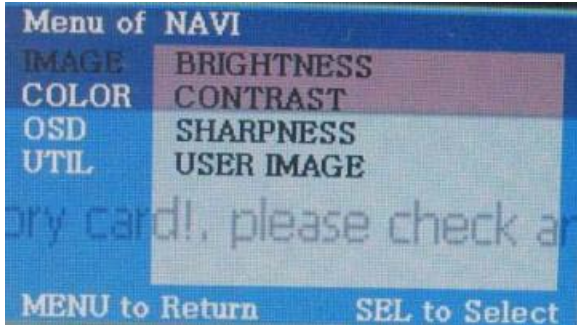

Analog RGB Mode

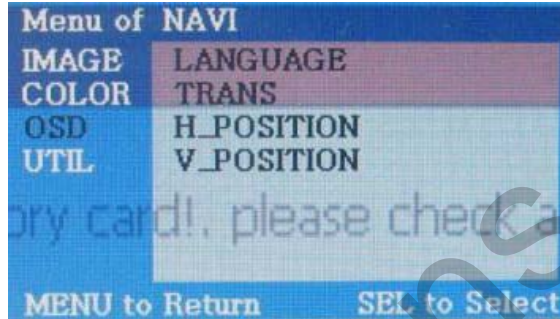

Analog RGB Mode

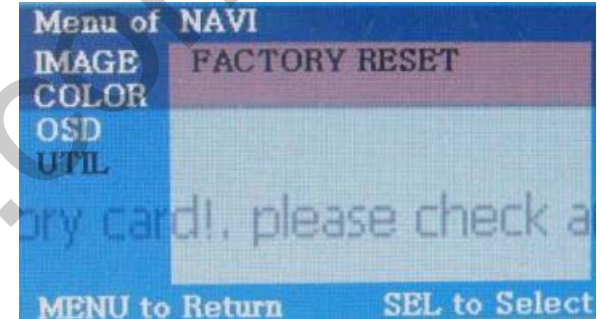

Analog RGB Mode



Video Mode



Video Mode

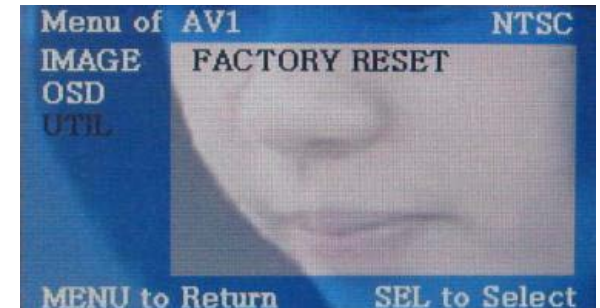

Video Mode

IMAGE

- BRIGHTNESS : adjusting brightness
- CONTRAST : adjusting contrast
- SATURATION : adjusting saturation
- HUE : adjusting hue
- SHARPNESS : adjusting sharpness
- USER IMAGE : able to make a choice among 4 set-colors of the screen

OSD

- LANGUAGE : choice of language
- TRANSPARENT : control over the transparency of OSD
- H_POSITION : control over the horizontal position of OSD
- V_POSITION : control over the vertical position of OSD

UTIL

- FACTORY RESET : able to reset the whole value of the NAVI or AV screens to the default.

3. Troubleshooting

Q. I can not switch A/V sources.

A. Check IR or Ground cable connection. Check LED lamps in the interface, if it is not on, check power cable.

Q. All I got on the screen is black.

A. Check second LED lamp of the interface is on, if not, check A/V sources connected are working well. (Second lamp indicates AV sources connected works well.) Check interface connection has been done well.

Q. Displayed image color is not proper. (too dim or not suitable color)

A. Try to select "INITIAL" in OSD menu, if it does not work, inform the manufacturer.)

Q. Rear camera image does NOT appear.

A. Set DIP switch #7 in "ON"

Q. Unwanted A/V mode is displayed. (A/V source switching order : OEM->RGB->AV1->AV2->AV3)

A. Check DIP Switch Setting.

Q. OEM image is not displayed.

A. Check interface's LCD In/Out cable connection. If the status keeps on, inform the manufacturer.

Q. Screen only displays white like left picture.

A. Check LCD out cable is connected well, if this status keeps, inform the manufacturer.