

GVIF MODULE SPECIFICATION

(Land Rover, Prius, Lexus etc.)

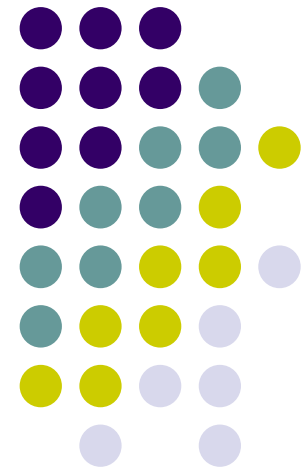

- . MODEL: GF08TW-V5.1
- . P/N : GF-0811-000



INDEX



- Updated points on this version3
- Precaution4
- Main Spec.5
- System Composition6
- Outline Dimension7
- External Appearance8
- Connector Pin Assignment10
- CAN Wiring12
- DIP Switch Setting13
- How to use OSD Keypad14
- OSD(On Screen Display)15
- FMTX Frequency Setting20
- How to use parking guide line21
- Product Composition22
- Installation Structure.....23
- FAQ.....24

-Updated points on Rev. 5



-Improved Quality

**-Auto detection for NTSC, PAL signals
(Available in Land Rover series)**

-Audio-Sel wires added in Power cable (12V comes out from each selected Audio-Sel wire. Ex) 12V comes out from RGB wire on RGB mode)

- Possible to move displayed image's position in RGB and AV mode. (Refer to page no. 18)

-Precaution



- You must keep the car key taken off from the car while you work this and finally, connect power of the interface.
- When to connect the interface cable, you must keep the power cable taken off.
- You must work this at the environment without any static electricity or damages.
- All of process on this installation should be done by professionals.
- You must not break the labels attached on the board, if it's broken, no warranty.
- When you receive this package you have to check whether there's any parts not included and you have to contact us right away.
- Our repair service do not accept any problems caused by user's any fault or carelessness.

-Main Spec.



1. Input Spec. (MULTI VIDEO INTERFACE)

- 3 x A/V Input (External video source).
- 1 x CVBS(REAR CAMERA) Input. (Rear camera source)
- 1 x Analog RGB Input (Navigation System output)
- 1 x LCD Input (Car system Input)
- 1 x GVIF Input

2. Output Spec.

- 1 x GVIF Output
- 4 x Audio Select (12V power comes out from 4wires of cable by video, Navi mode)

3. Power Spec.

- Input Power : 8VDC ~ 24VDC
- Consumption Power : 12WATT, Max

4. Switch Input mode

- Input Video MUTE Function : Possible to make each input mute by operating Dip S/W.
- Possible to switch Input mode with remote
- Possible to switch Input mode with switch for source toggle
- Possible to switch mode through CAN (Only available in Land Rover series)

-System Composition

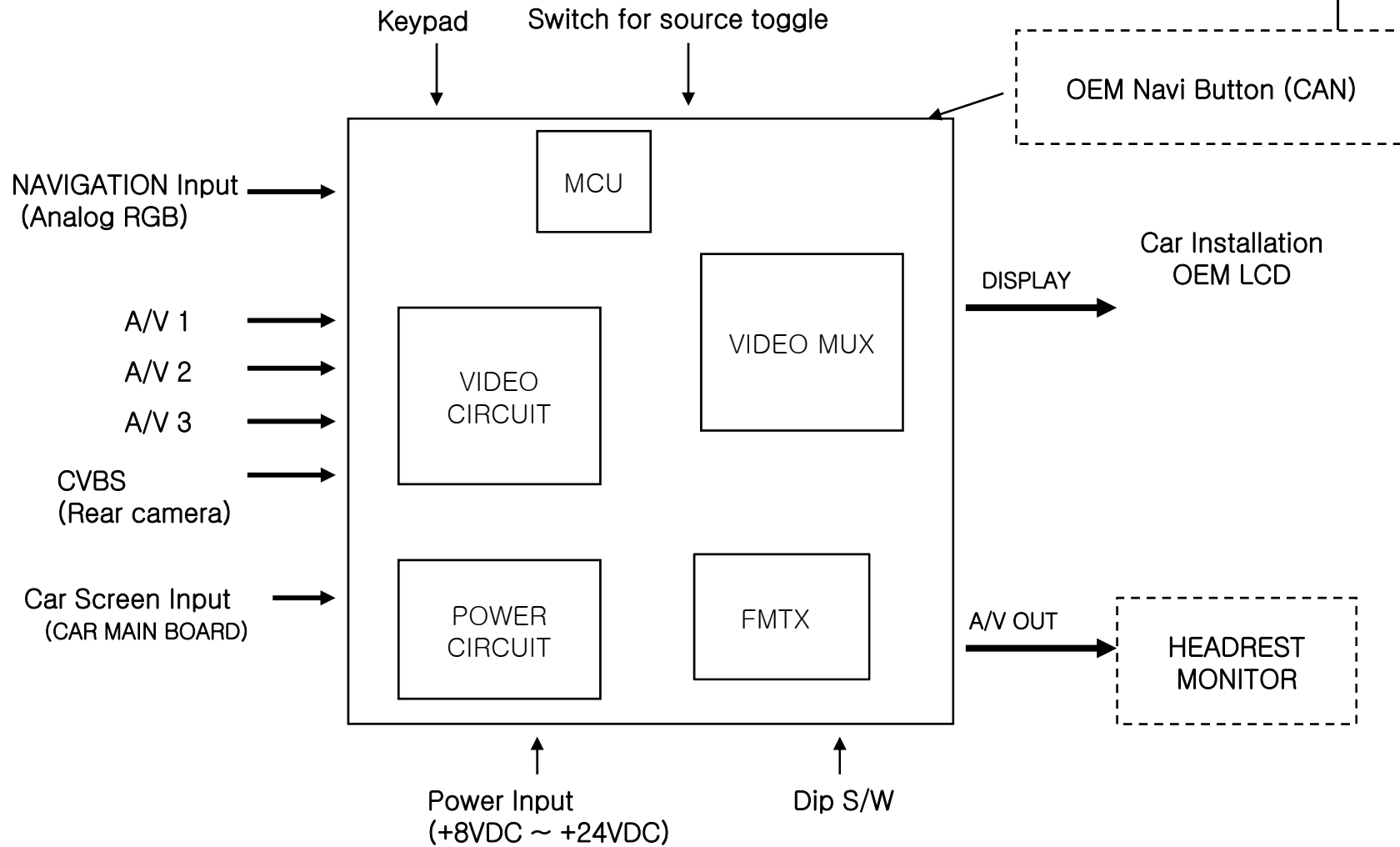

-Outline Dimension

155mm * 93mm * 20mm



155mm



93mm

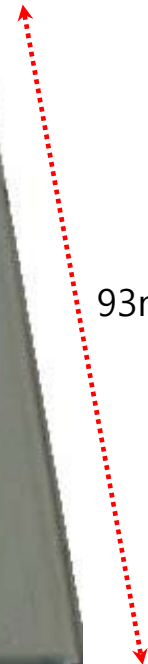

20mm



-External Appearance



-External Appearance



↑
Power

↑
MODE

↑
RGB(IN)

↑
A/V(IN/OUT)



↑
LCD (IN/OUT)

↑
KEYPAD

↑
DIP S/W

↑
LED

-Connector Pin Assignment

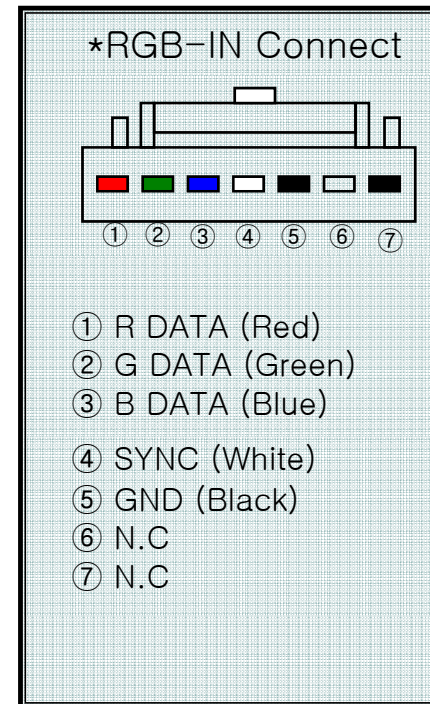
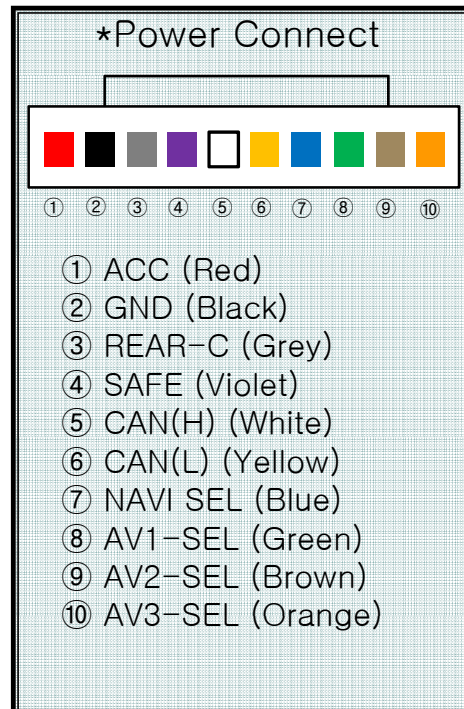
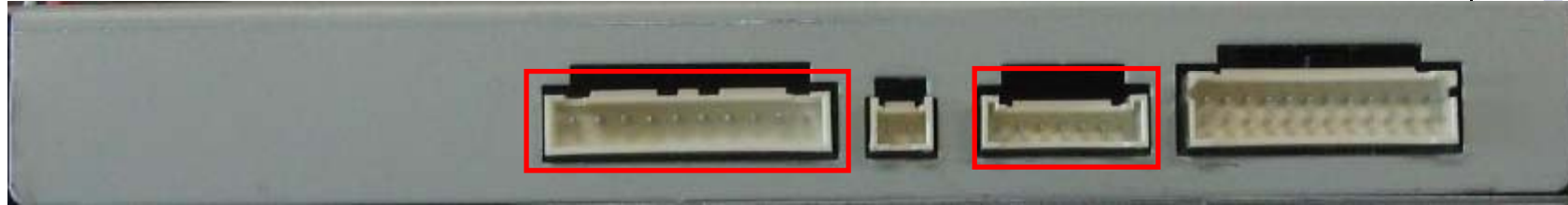

-Connector Pin Assignment



* Power Cable

FILTER
& FUSE BOX

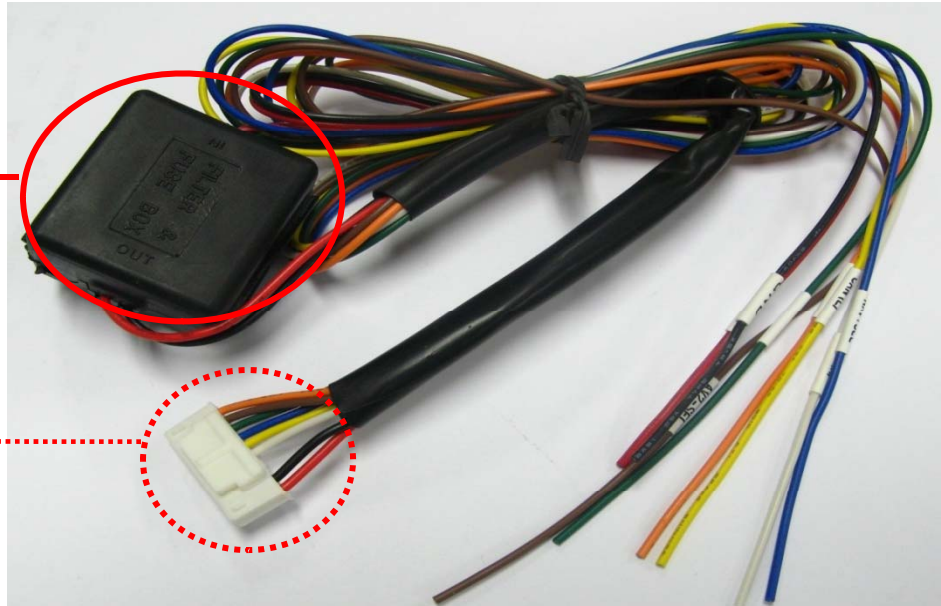

1m

-CAN Wiring

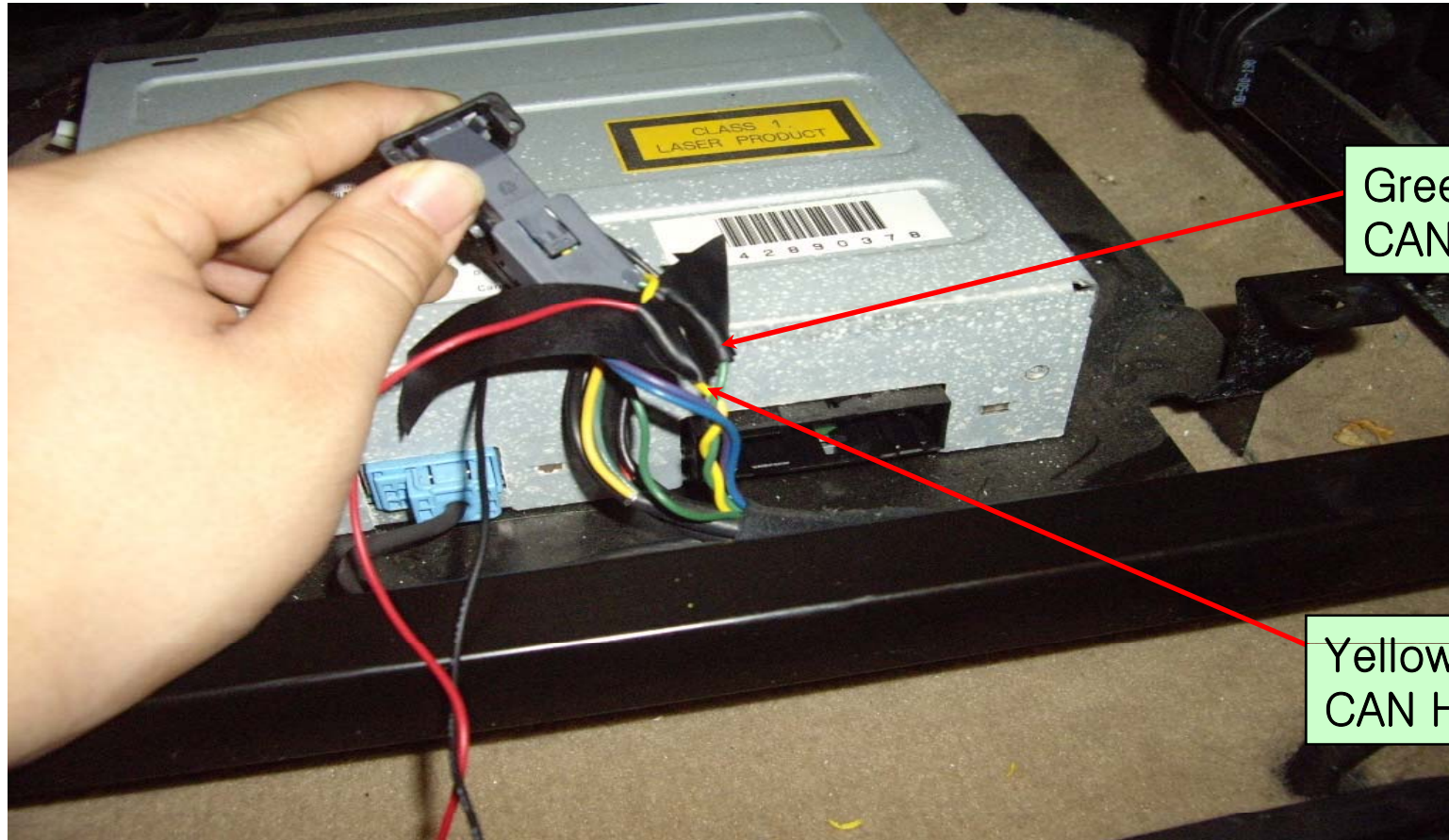

Green:
CAN LOW

Yellow:
CAN High

*** The color of CAN wires coming from the car can be different by each countries that the car import or any other circumstances.**

-DIP SW Setting



※ ON : DOWN, OFF : UP

#PIN	FUNCTION	DIP S/W Selection
1	RGB INPUT MUTE	ON : Skipping RGB Mode OFF : RGB Display
2	A/V 1 MUTE	ON : Skipping A/V 1 OFF : A/V1 Display
3	A/V 2 MUTE	ON : Skipping A/V 2 OFF : A/V2 Display
4	A/V 3 MUTE	ON : Skipping A/V 3 OFF : A/V3 Display
5	To select car model	ON : Lexus OFF : Landrover
6	To select original NAVI	ON : For using original NAVI OFF : Not use original NAVI
7	Rear Mode	ON : External Rear Camera OFF : OEM Rear Camera
8	N.C	

※DIP S/W Use Example

[Lexus]

- Use Input Mode : MAIN + A/V 3
- Rear Camera : When to be installed W on CVBS 4

- ▷ DIP S/W : 1,2,3 -> ON (INPUT MODE SKIP)
- ▷ DIP S/W : 4 -> OFF (enable A/V3)
- ▷ DIP S/W : 5 -> ON
- ▷ DIP S/W : 6 -> OFF
- ▷ DIP S/W : 7 -> ON (enable CVBS4)
- ▷ DIP S/W : 8 -> OFF



-How to use remote



Dimension : 85 * 40 * 8 (mm)

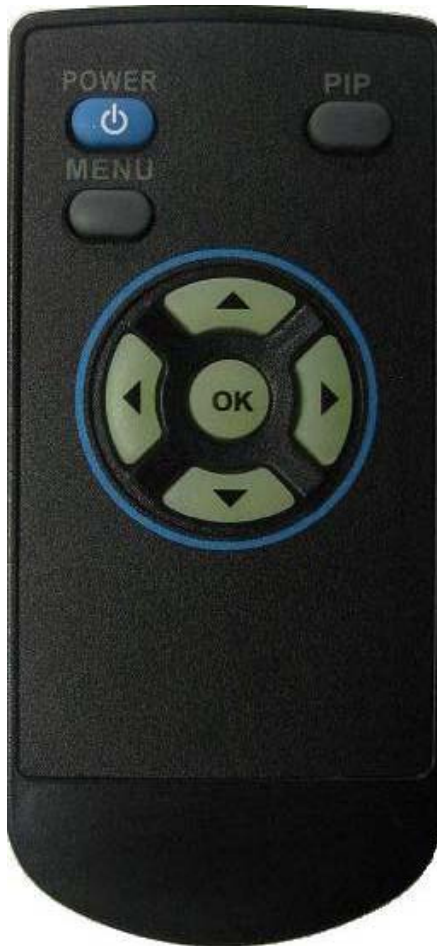

POWER

MENU : OSD Menu

OK : Select, Mode change

▲ : Up

▼ : Down

◀ : Left

▶ : Right

*FACTORY MODE (Interface setting)

: Operated with pressing ▲ -> ▼ -> ▲ -> MENU
keys in the remote in sequence.

-OSD(On Screen Display)



- Analog RGB Mode

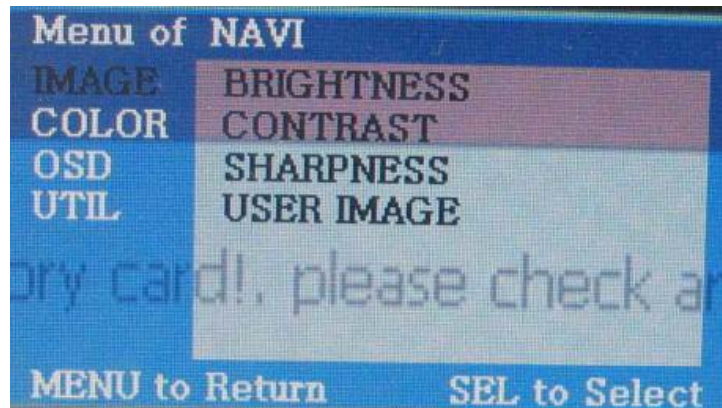

- Video Mode



IMAGE Menu

- BRIGHTNESS
- CONTRAST
- SATURATION
- HUE
- SHARPNESS
- USER IMAGE

OSD(On Screen Display)



- Analog RGB Mode
- Video Mode

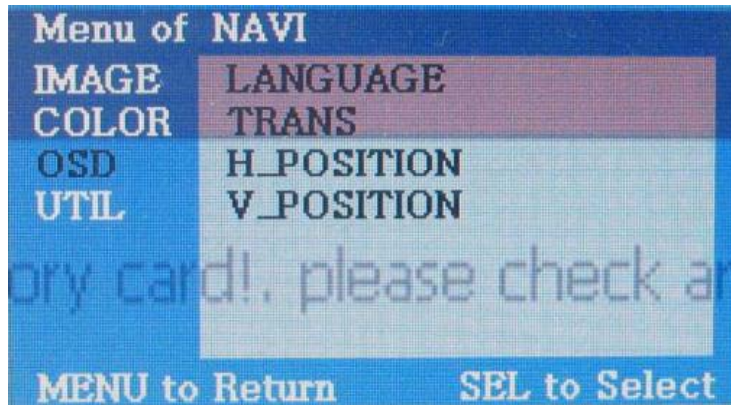

OSD Menu

- **LANGUAGE** : Language selection (only available in English)
- **OSD TRANS** : OSD window transparency setting
- **OSD H_POS** : Move of OSD window to Left, Right
- **OSD V_POS** : Move of OSD window to Up, Down

OSD(On Screen Display)



- Analog RGB Mode
- Video Mode

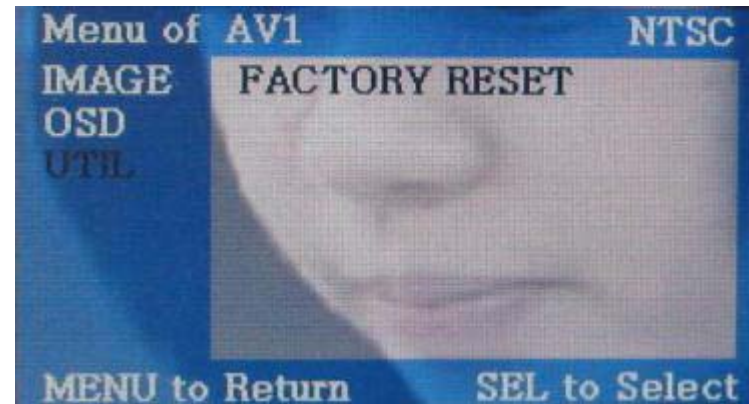
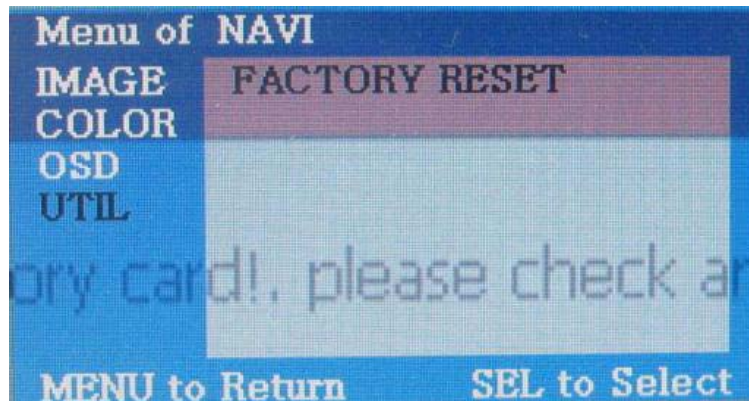

UTIL Menu

- **FACTORY RESET** : Initializing OSD setting value

OSD(On Screen Display)



- **Factory Mode**

-Operated with pressing ▲ -> ▼ -> ▲ ->MENU keys of the remote in sequence.

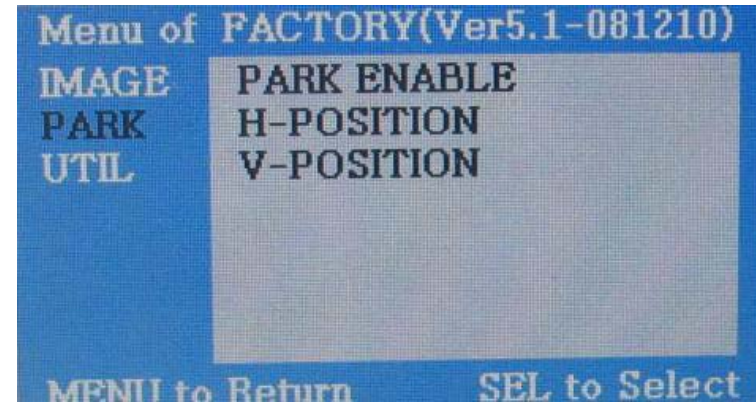
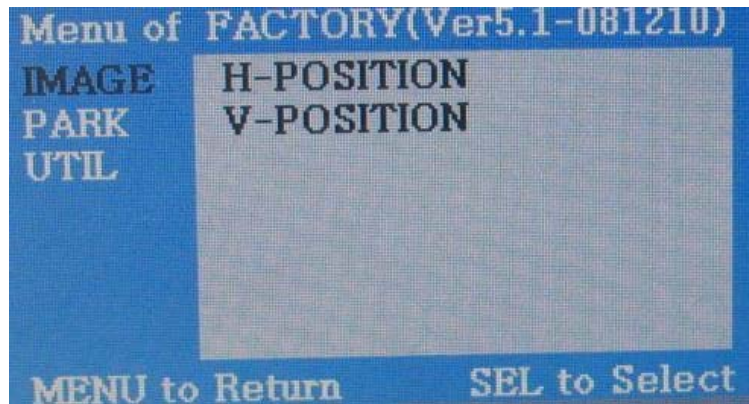

Factory Mode

- **IMAGE :**

- H-POSITION : Move of Screen to Left, Right
- V-POSITION : Move of Screen to Up, Right

- **PARK :** Referring to the page no. 21

OSD(On Screen Display)



- **Factory Mode**

-Operated with pressing ▲ -> ▼ -> ▲ ->MENU keys of the remote in sequence.

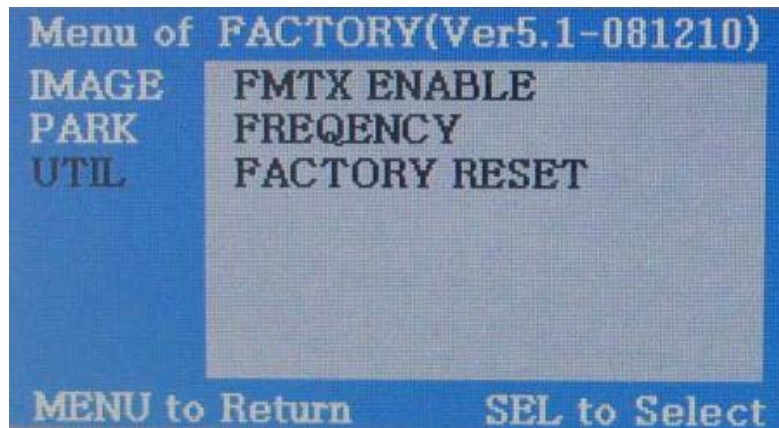

Factory Mode

- **UTIL :**
 - FMTX ENABLE : FMTX Setting
 - FREQUENCY
 - FACTORY RESET

-FMTX Frequency



Factory Default : FMTX USE – ON, FREQUENCY – 88.2MHz

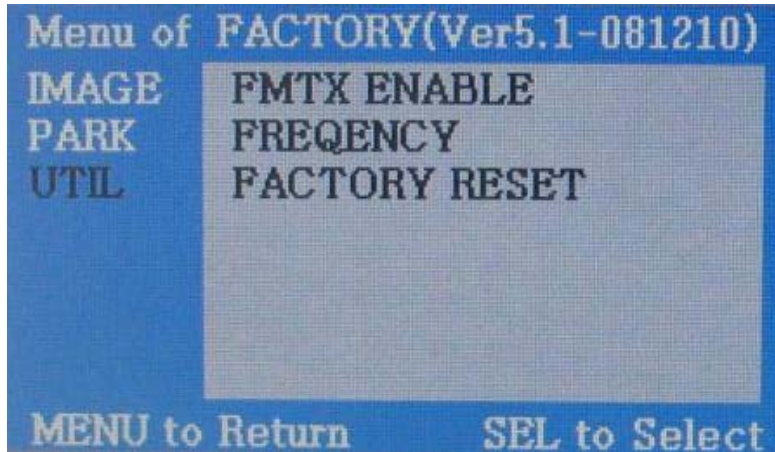

-Get the Factory Mode Operated with pressing UP->DOWN->UP->MENU keys of t he keypad in sequence

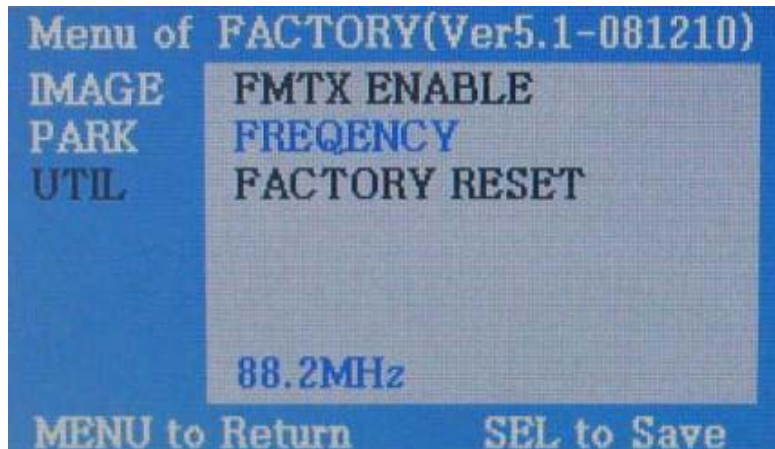

-Set "FM-TX USE" to "ON" like the left picture.
(‘ON’ is Default). control the frequency by "UP", "Down" keys. At the bottom, you can see present frequency and control it from 87.5MHZ to 108MHZ. (1MHZ per each time to press)

※If you do not want this function, kindly set "FM-TX USE" to "OFF"

-How to use parking guide line



Factory Default : DISPLAY – ENSABLE

①

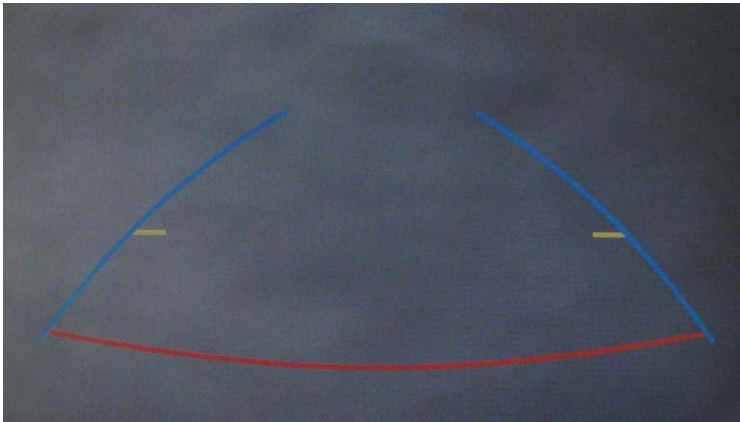

① When the car is in reverse, if press 'UP' key for 2 sec, the guide line appears on the screen.

②

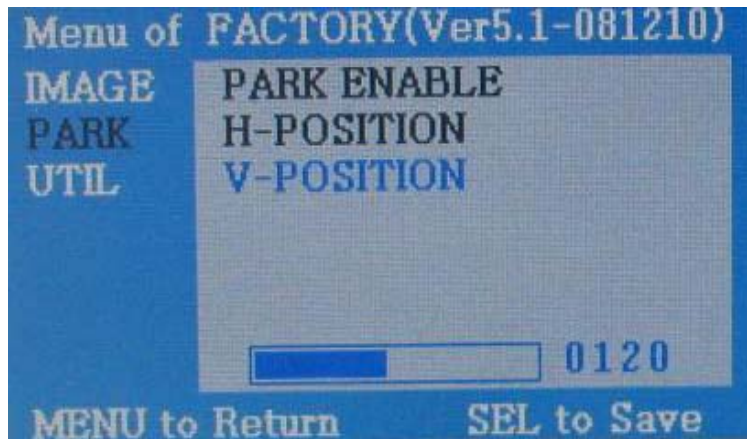

② If you need to move the line position, press 'SEL' key on the above step.
(Use 'Up', 'Down' Key of Keypad)

※If you do not want this function, kindly set "PARK ENABLE" to "OFF"

-Product Composition



OSD Keypad Or Remote : 1 EA
LCD In/OUT Cable : 1 EA
RGB Cable : 1 EA
Toggle Switch : 1 EA

Power Cable: 1 EA
A/V Cable : 1 EA
Ground (IR) Cable : 1 EA

-Installation Structure

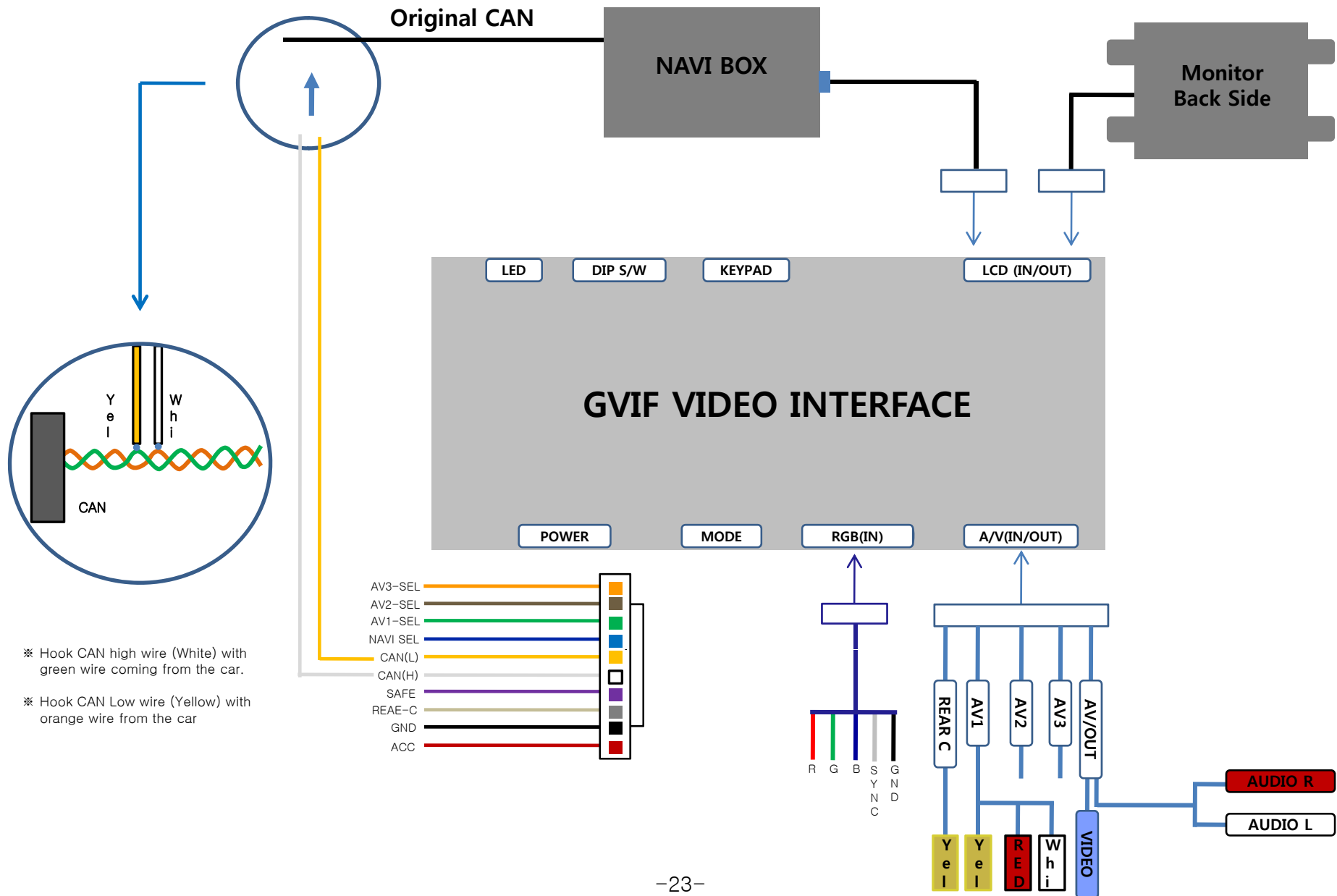

-FAQ



1. When can not change mode.

- Check if the Ground (IR) cable is connected or not.
- Check if LED lamp is turned on or not. If it is not turned on, Check if power cable is connected or not.
- Check if CAN cables are connected well.

2. When the screen is displaying only black color.

- Check if 2nd LED is turned on or not. If it is not turned on, please check all video sources that you will connect with the interface is operating well or not.
- Check if interface is connected well.

3. When displayed color of screen is not proper. (If it's too dark or the color is not proper)

- Try to select "Initial" on OSD menu, If the color of screen keeps on displaying wrong color, you have to ask manufacturer for the problem.
- Try to adjust Color, Contrast, Brightness by the remote.

4. When Back-up camera is not displayed on the screen.

- Put Dip S/W no.7 down.

5. When the mode you set is not skip.

- Check if Dip S/W is set properly.

6. When Main screen on the car is not displayed.

- Check if In/Out cables are connected well. If it keeps showing the same problem, you have to ask manufacturer for the problem.

7. When the screen is displaying only white color.

- Check if out cable is connected well. If it keeps showing the same problem, you have to ask manufacturer for the problem.